

Counter Top Convection Ovens

Standard Features

- Heavy duty exterior/interior stainless steel construction
- Reinforced door with with double pane tempered cool to touch glass
- Advanced air flow design for even baking
- 120 minute timer
- Manual controls with temperature settings from 100°F - 500°F
- Interior light
- Removable wire rack holder
- 1.1” legs for CTCO-25 & CTCO-50
- 0.8”-3.9” adjustable legs for CTCO-100
- Distance between oven racks is 1.85”
- Chrome oven racks
- CTCO-100 includes a water line connection kit, 3/8 “Slip” style connector / Accepts 3/8 OD Tubing

MODELS:

CTCO-25 / CTCO-50 / CTCO-100



CTCO-25



CTCO-50



CTCO-100



1 YEAR PARTS AND LABOR WARRANTY (US ONLY)



Conforms to ANSI
STD Z83.11-2009 (2011)
Certified for CSA
STD 1.8B-2009 (2011)
Conforms to NSF/ANSI STD.4



REV. 05/23

“WE MAKE THE KITCHEN BETTER!”

SPECIFICATIONS

Models	Shelves	Oven Rack Dimensions (inch)	Amps(A)	Voltage (V/Hz/Ph)	Watts (W)	Plug	Exterior Dimensions (inch)	Interior Dimensions (inch)	Net Weight (lbs)	Gross Weight (lbs)
CTCO-25	3	13 ^{7/10} ×11	12	120/60/1	1440	NEMA-L5-15P	18 ^{3/4} ×19 ^{3/4} ×15	14 ^{1/10} ×13×8 ^{3/5}	43	47.4
CTCO-50	4	18×12 ^{4/5}	13	120/60/1	1550	NEMA-5-20P	23×22 ^{1/2} ×16 ^{1/2}	18 ^{2/5} ×15 ^{3/5} ×10	55.1	61.7
CTCO-100	4	26×17 ^{7/10}	22	208/60/1	5450	NEMA-6-300P	31 ^{13/16} ×27 ^{3/32} ×23 ^{5/32}	27 ^{2/5} ×19×13 ^{1/2}	102.3	108

PLAN VIEW

CTCO-25

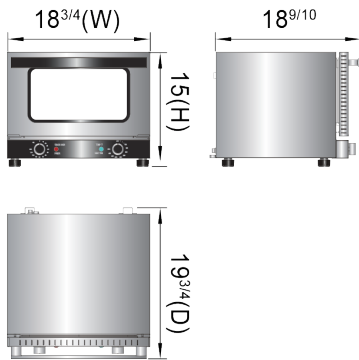

CTCO-50

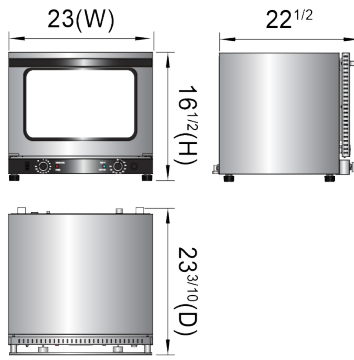

CTCO-100

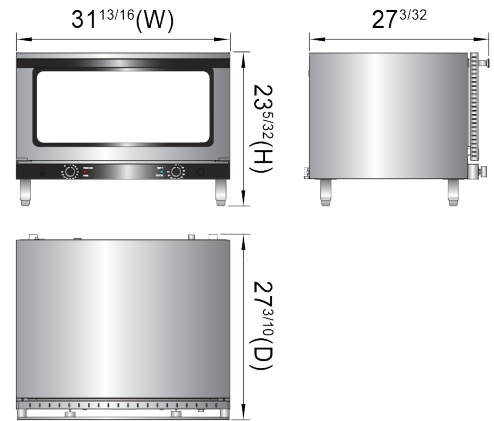

Controls



ChromeOvenRacks

